

Mesa Redonda Paulista

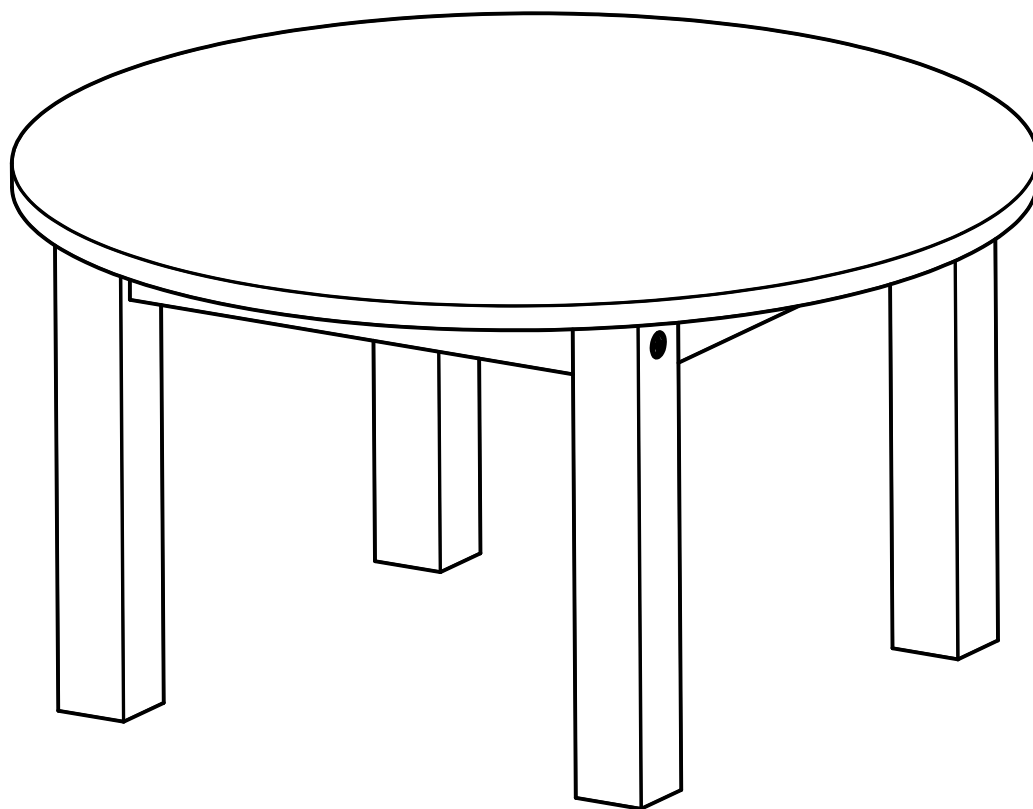



Ler e observar atentamente todas as instruções antes de iniciar a montagem, A montagem do produto deverá ser feita em uma superfície limpa e plana.

Aconselhamos utilizar a embalagem para forrar o chão a fim de não danificar o produto.

Nos produtos verificar as numerações gravadas nas peças para a montagem correta do móvel.

Limpeza

Madeira

Para a limpeza do seu móvel, utilize somente sabão neutro e um pano levemente umedecido.

Dê preferência para panos brancos isso evitar manchas no produto.

Na limpeza diária, não utilizar produtos abrasivos, como palhas de aço, esponja de lã de aço, álcool, saponáceo ou outros que possam riscar ou descolar a camada protetora. Durante a limpeza, deixe o ambiente bem arejado

Dobradiças e corrediças

Utilizar para a limpeza um pano macio ou pincel de cerdas suave para remover a poeira.

Evitar contato com produtos como sal, limão e vinagre podem acelerar a oxidação dos acessórios metálicos

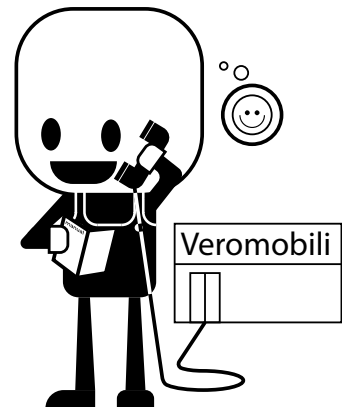
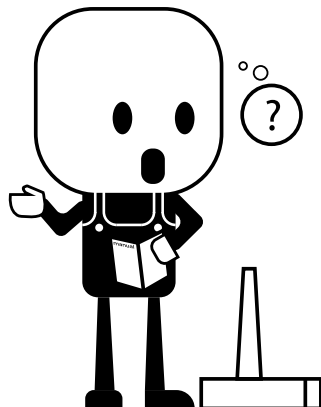
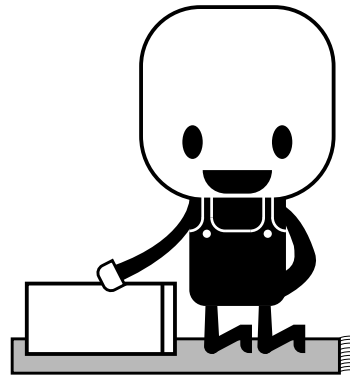
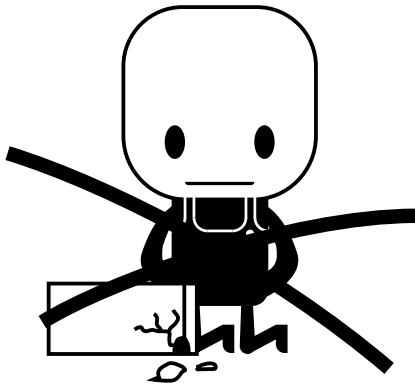
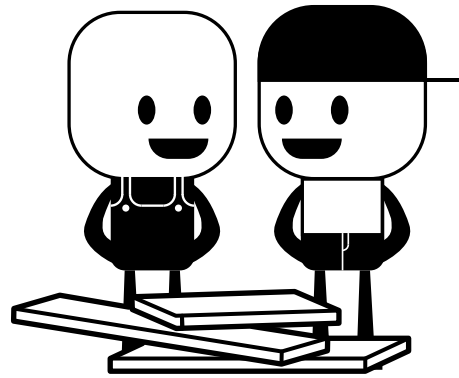
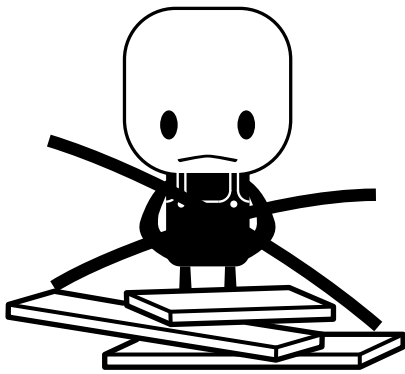
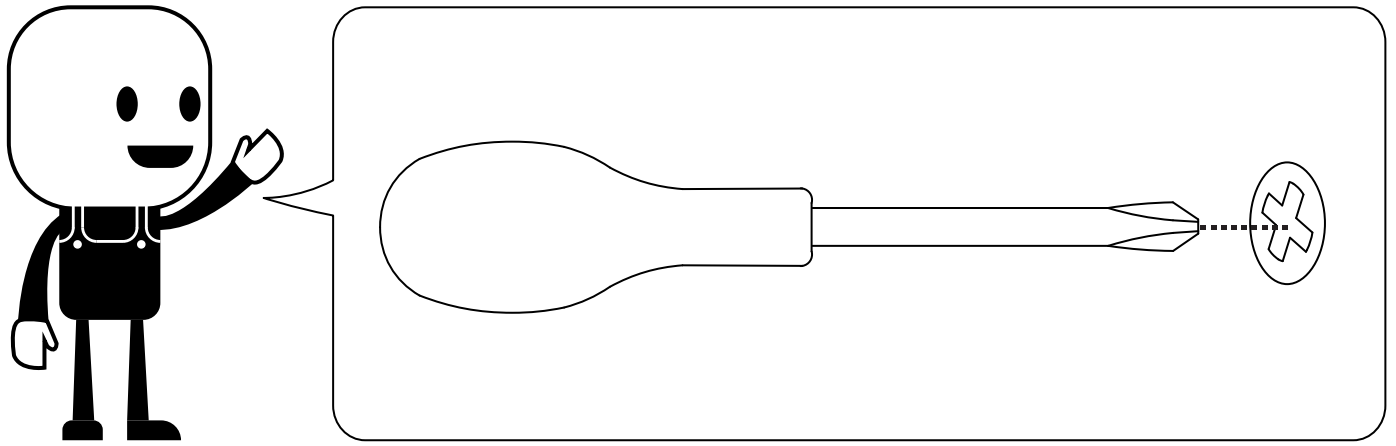

(17) 3266-2174
(17) 3266-2188

A  4x
Parafuso 5,5x65

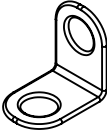
B  4x

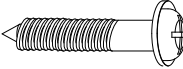
C  4x
Parafuso flange 4x25

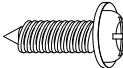
D  4x
Parafuso flange 4x14

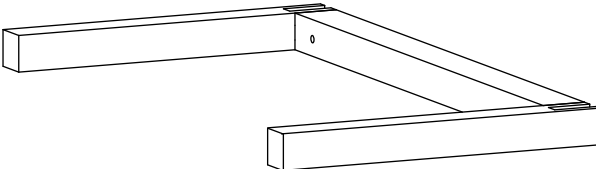
1  2x
Pés

2  2x
Estrutura

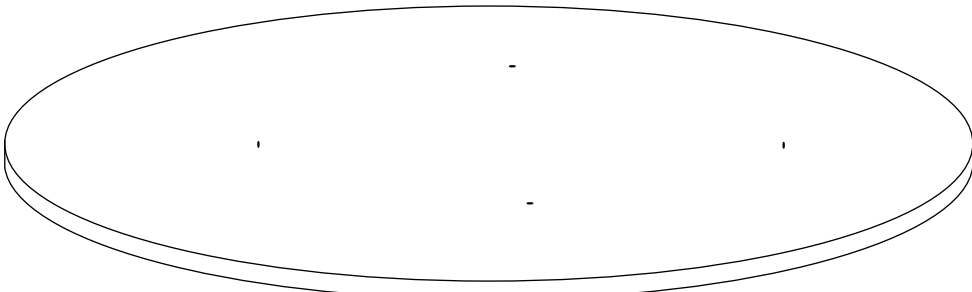
3  1x
Tampo

01

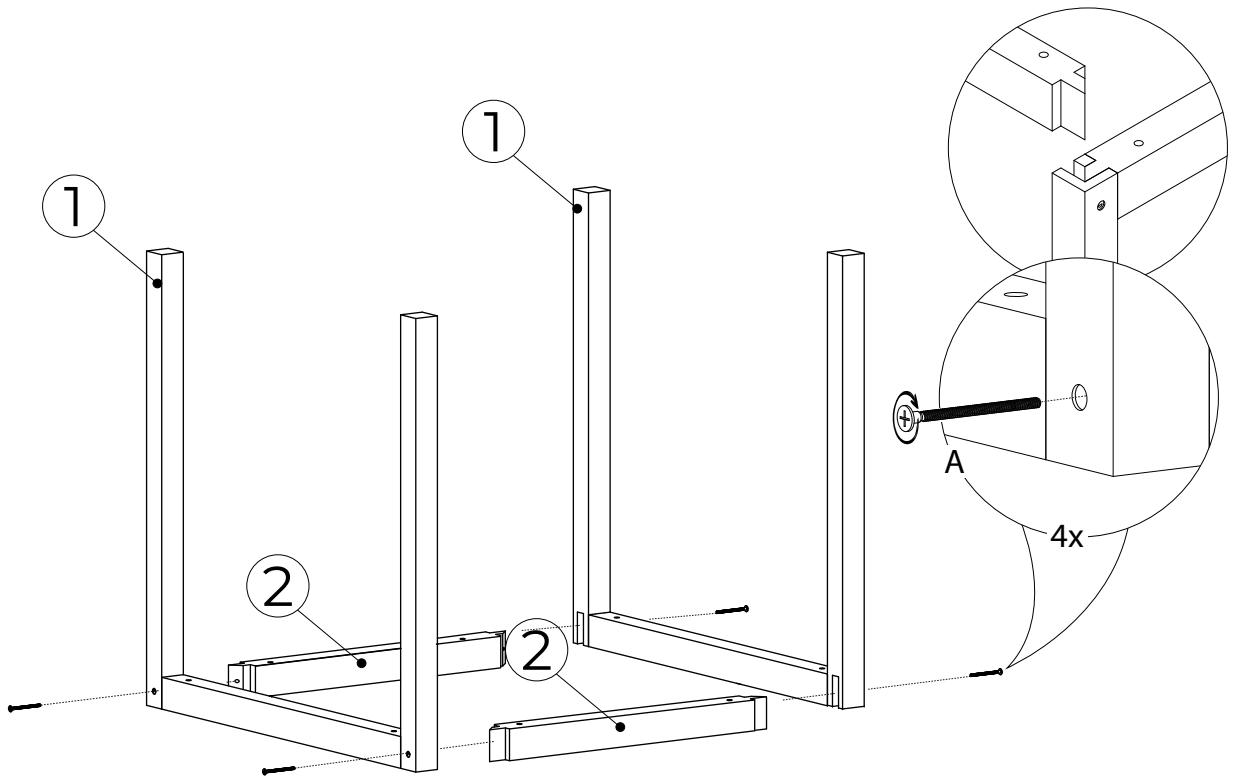

02

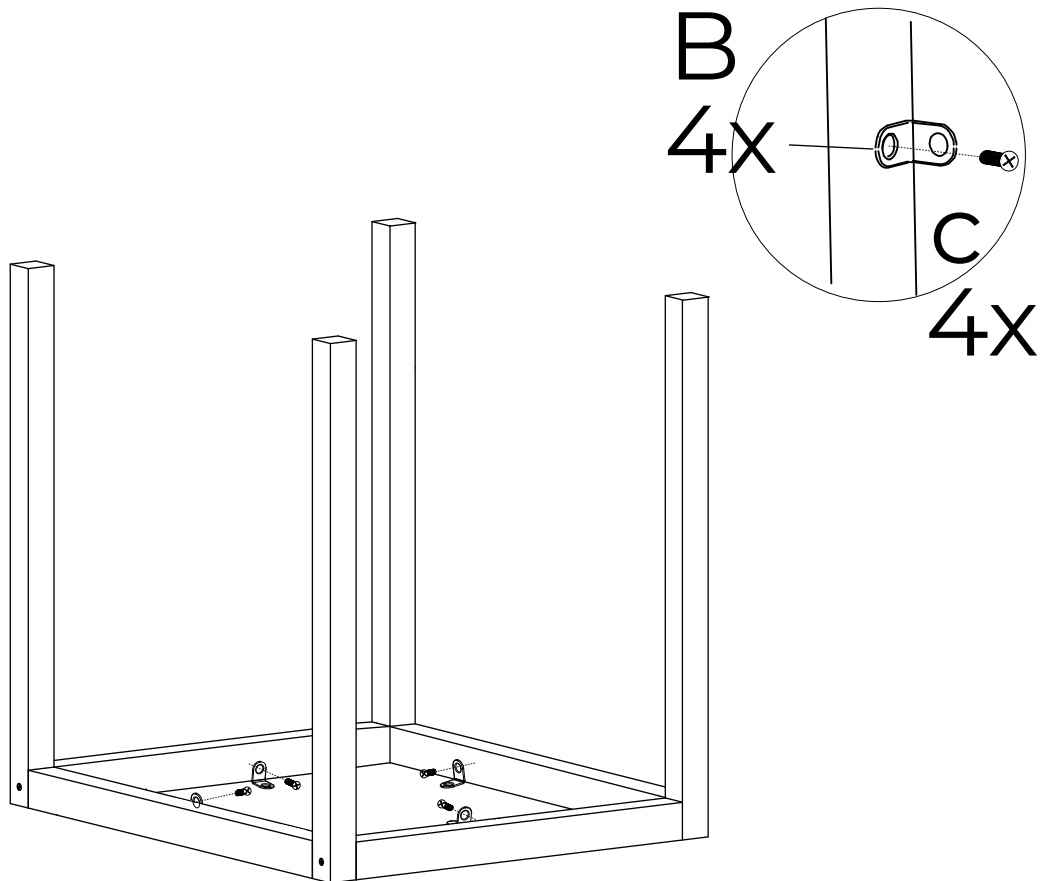

03

